

A glowing cylindrical garden light fixture is shown in a garden setting. The light is illuminated, casting a warm glow. It is positioned next to a brick path and some greenery.

el|umière™

BY BIRKDALE

12V GARDEN LIGHTING SYSTEM









HOW DOES YOUR GARDEN **GLOW?**

COMPLETE YOUR GARDEN
LIGHTING IN **3 EASY STEPS**
NO ELECTRICIAN REQUIRED

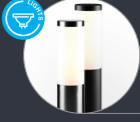
BIRKDALESALES.COM

THE RANGE

COMPLETE YOUR GARDEN LIGHTING IN 3 EASY STEPS.

STEP 1 SELECT YOUR LIGHTS		GARDEN DECK LIGHT KIT WARM WHITE / STAINLESS STEEL / 1W LED	PAGE 10
		GARDEN SPOTLIGHT KIT WARM WHITE / BLACK / 2W LED	PAGE 11
		GARDEN SPOTLIGHT WARM WHITE / 2W LED (SMALL) / 3W LED (LARGE) / 2W STAINLESS STEEL	PAGE 12
		GARDEN BOLLARD WARM WHITE / BLACK / STAINLESS STEEL / 3W LED	PAGE 14
		DECK LIGHT WARM WHITE / 1W LED (PACK 4) / 2W LED (LARGE)	PAGE 16
STEP 2 CHOOSE YOUR CONNECTORS & CABLES		CABLES & CONNECTORS 0.2M / 1M / 2M / 5M / 10M CABLES / T-PIECE CONNECTORS	PAGE 18
		AUTOMATIC LIGHT SENSOR AUTOMATICALLY TURN YOUR LIGHTS ON & OFF	PAGE 19
STEP 3 GRAB A TRANSFORMER		OUTDOOR TRANSFORMER 72W / 6000MA TRANSFORMER	PAGE 20
ACCESSORIES CUSTOMISE YOUR SYSTEM		BULBS WARM WHITE / COOL WHITE	PAGE 22
		LENSES BLUE / GREEN / RED	PAGE 24



DID YOU KNOW?

IT'S NICE TO ENJOY YOUR GARDEN BY DAY, BUT WHY NOT GET THE MOST OUT OF YOUR OUTDOOR SPACE WITH SOME CLEVER HOME GARDENING LIGHTING IDEAS.

THERE'S MORE TO GARDEN LIGHTING THAN AN AUTOMATIC FLOOD LIGHT THAT IS TRIGGERED BY YOUR DOG OR CAT AT ALL HOURS OF THE NIGHT.

SHADOW LIGHTING EFFECTS

A good example of using light is to highlight one feature to bring out another, such as illuminating a statue or figurine also creates a shadow onto a fence. Using a spot light pointing upwards can highlight a row of flowers or plants, whilst also lighting a tree behind. You can position the lights at many angles to achieve this result, experiment during the day first as you can clearly see the important parts of your garden.

PATHWAY & DRIVEWAY LIGHTING

Adding outdoor lighting along paths and walkways can help to extenuate the edges of the path, but also illuminate plants in the garden next to it. The ideal light fitting for this is the spotlight or low level bollard which is designed to push the light downward and reduce glare. Your main driveway is an ideal place to use in ground or deck lights which show a direct route to the house entrance and can be used in conjunction with bollard lights for extra security and effect.

LIGHTING A DECKING OR PATIO AREA

Lighting decking areas can add a finishing touch to the look, and create an almost fairytale ambiance. They take a little more work to fit them and install but the finished result is one of the best around, and will really set your garden apart from the rest. Using LED in the decking is ideal as the lamp produces very little heat and will be safe to touch for children.

GARDEN UP-LIGHTING IDEAS

Using a bit of natural height can help to expose more of your garden, and it also helps with security. This way you can bring the illusion of extra height by aiming the beam at other branches.

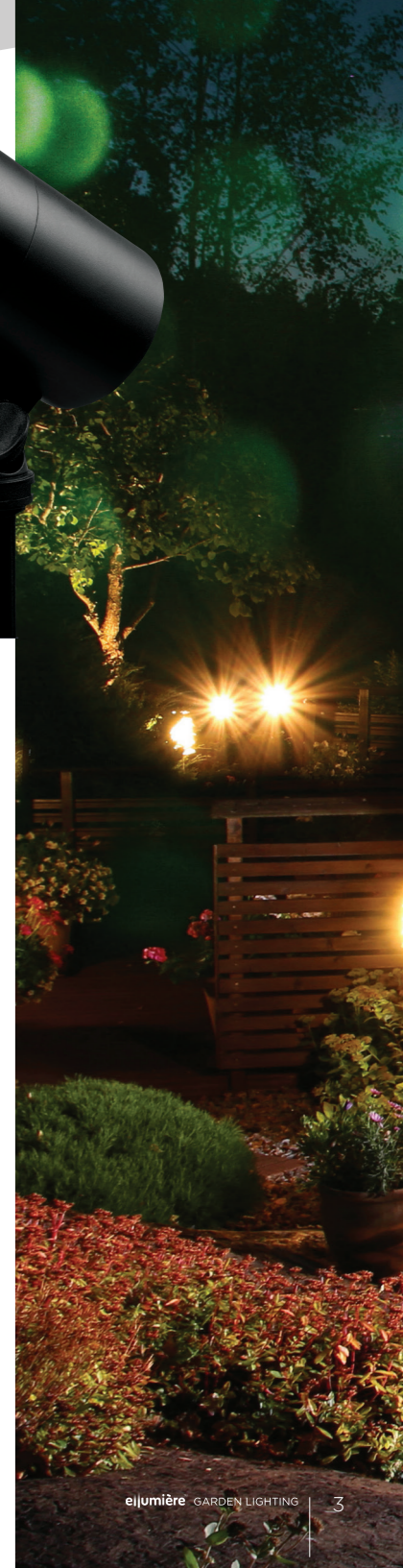

HOW DOES YOUR GARDEN GLOW?

CONNEXT



GARDEN LIGHTING SYSTEM

- **No electrician required*** to install
- Easiest 12V Garden Lighting System on the market
- Up to 12 Lights per transformer - any configuration
- No output variance
- Water resistant lighting
- Waterproof transformer
- 2 Year Warranty
- Whenever you see the CONNEXT logo, you know this item will be compatible with your system

‘CONNEXT’ IS
A PLUG ‘N’ PLAY
GARDEN LIGHTING
SYSTEM THAT
IS SO SIMPLE.

*Standard 240V socket required

BUY IT NOW

4 x SPOTLIGHT KIT

Includes:

4 x 2W Spotlights
1 x Transformer
1 x 10m Cable
3 x 1m Cable
3 x T-Piece Connectors

4 x DECK LIGHT KIT

Includes:

4 x 1W Deck Lights
1 x Transformer
1 x 10m Cable
3 x 1m Cable
3 x T-Piece Connectors



WANT SOMETHING QUICK AND EASY? THE 'EXPANDABLE' STARTER KITS HAVE EVERYTHING YOU NEED - READY TO GO.

The ellumiere range features up to 12 lights per transformer in any configuration with no electrician required for installation. Fully waterproof and with a 2 year warranty, ellumiere is the easiest 12V 'Plug n Play' garden lighting system around.

Plug your transformer into the waterproof socket and this will convert 240V to 12V giving you a safe, easy and reliable mains powered LED lighting system in a flick of a switch.

Then when you're enjoying the beautifully illuminated surroundings and want to add more lights the expandable starter kits still has the capacity for another 8 lights and 37m of cable.

SEE PAGE 10-11 FOR SPECIFICATIONS

OR BUILD YOUR OWN...

A GREAT CUSTOM LIGHTING SYSTEM STARTS WITH GREAT PLANNING.

COMPLETE YOUR GARDEN LIGHTING IN 3 EASY STEPS



SELECT YOUR LIGHTS

Any style or size
MAX 12 LIGHTS PER TRANSFORMER



CHOOSE YOUR CONNECTORS & CABLES

Various lengths
MAX 50M PER TRANSFORMER



GRAB A TRANSFORMER

Plug in and enjoy
IT'S THAT SIMPLE

Think about what type of lights you would like to have in your outdoor space. Choose from small spotlights to light up smaller plants or larger spotlights to highlight a beautiful tree. Bollard lights are a great addition to a driveway or path, and deck lights create a fantastic feature along the edges of decking or stairs.

Now you have your lights placed, it's time to work out your cables. Measure the distance between each light and back to your power source and write these measurements on your plan.

You will need a T-Piece Connector for every light except the last light in your sequence. Indicate these on your plan.

Now measure the distance from your power supply to the first light and mark this on your plan.

Check the total length of all your cables does not exceed 50m.

Once you're home, simply connect them all up, turn them on, sit back and enjoy. It's that simple.

NO ELECTRICIAN REQUIRED.



A GREAT CUSTOM
LIGHTING SYSTEM
STARTS WITH
GREAT PLANNING.

STEP 1 - SELECT YOUR LIGHTS
GARDEN DECK LIGHT KIT

WARM WHITE / STAINLESS STEEL / 1W LED

1W DECK LIGHT KIT	
Power	1W
Nominal Voltage	12V
Bulb type	LED Non-replaceable
Lumens	120 LUMENS
Cable Length	0.2m
Construction	Stainless Steel housing Heavy Duty Glass lens
Package contents	4 x 1W Deck Lights 1 x Transformer 1 x 10m Cable 3 x 1m Cable 3 x T-Piece Connectors
Hole required	32mm Ø
Product code	01EL200



ADD A LITTLE SOMETHING EXTRA WITH A LIGHT SENSOR
 AUTOMATICALLY TURN YOUR LIGHTS ON & OFF AT NIGHT. SEE PAGE 19

STEP 1 - SELECT YOUR LIGHTS
GARDEN SPOTLIGHT KIT

WARM WHITE / BLACK / 2W LED

2W SPOTLIGHT KIT	
Power	2W
Nominal Voltage	12V
Bulb type	LED MR11
Lumens	170 LUMENS
Cable Length	0.5m
Construction	Black plastic housing
Package contents	4 x Small Spotlights 1 x Transformer 1 x 10m Cable 3 x 1m Cable 3 x T-Piece Connectors
Product code	01EL201



IDEAL FOR ILLUMINATING WATER FEATURES, PLANTS, SHRUBS, ORNAMENTS & TREES.



READY TO GO

All bollard & spotlights come complete with a base and a garden spike for different installation applications.

No limitations.

2W SMALL GARDEN SPOTLIGHT
01EL062

3W LARGE GARDEN SPOTLIGHT
01EL063

2W STAINLESS STEEL GARDEN SPOTLIGHT
01EL066



STEP 1 - SELECT YOUR LIGHTS

GARDEN SPOTLIGHT

WARM WHITE / 2W LED STAINLESS STEEL / 2W LED (SMALL) / 3W LED (LARGE)



	2W SPOTLIGHT	3W SPOTLIGHT	2W S/S
Power	2W	3W	2W
Nominal Voltage	12V	12V	12V
Bulb type	LED MR11	LED MR16	LED MR11
Lumens	170 LUMENS	250 LUMENS	170 LUMENS
Cable Length	0.5m	0.5m	0.5m
Construction	Black plastic housing	Black plastic housing	Stainless steel housing
Package contents	1 x Light fixture with base & plastic spike 1 x Bulb	1 x Light fixture with base & plastic spike 1 x Bulb	1 x Light fixture with base & stainless steel spike 1 x Bulb
Requires	12V transformer <small>(not included in pack and sold separately)</small>	12V transformer <small>(not included in pack and sold separately)</small>	12V transformer <small>(not included in pack and sold separately)</small>
Adjustable head	Yes	Yes	Yes
Product code	01EL062	01EL063	01EL066

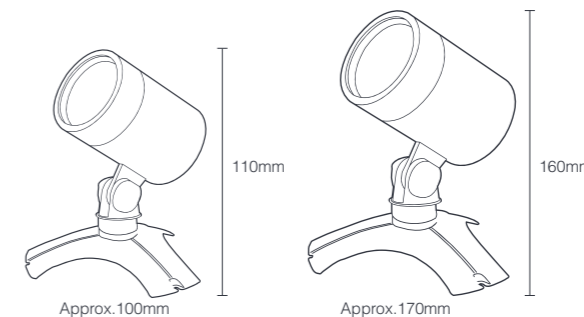

Available as a Starter Kit

Includes: 4 x Small Spotlights, 1 x Transformer, 1 x 10m Cable, 3 x 1m Cable, 3 x T-Piece Connectors

Product Code 01EL201



DON'T FORGET
Make sure you only use Ellumiere replacement bulbs to ensure the system works properly.
Using Ellumiere bulbs ensures the brightness does not differ.

PERFECT FOR ILLUMINATING PATHWAYS, PLANTS AND SHRUBS.

3W STAINLESS STEEL GARDEN BOLLARD
01EL081

3W BLACK GARDEN BOLLARD
01EL082



STEP 1 - SELECT YOUR LIGHTS
GARDEN BOLLARD

WARM WHITE / BLACK / STAINLESS STEEL / 3W LED



	3W BOLLARD S/S	3W BOLLARD BLACK
Power	3W	3W
Nominal Voltage	12V	12V
Bulb type	LED MR16	LED MR16
Lumens	40 LUMENS	40 LUMENS
Cable Length	0.5m	0.5m
Construction	Stainless steel housing	Black coated housing
Package contents	1 x Light fixture with base & metal spike 1 x Bulb	1 x Light fixture with base & metal spike 1 x Bulb
Requires	12V transformer <small>(not included in pack and sold separately)</small>	12V transformer <small>(not included in pack and sold separately)</small>
Product code	01EL081	01EL082

TOP TIP
The bollard comes with a base which allows it to be secured down.
Alternatively, the base can be unscrewed and replaced with a metal spike.

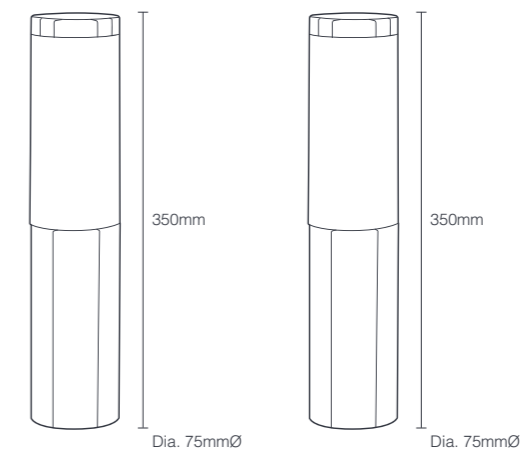



DID YOU KNOW?
 You can customise your lights through different coloured bulbs and lenses.
 View full range of accessories on pages 22-25.

IDEAL FOR LIGHTING DECK AREAS, PATIOS, AND STEPS FOR STYLE & SAFETY. CAN BE MOUNTED BOTH VERTICALLY & HORIZONTALLY.

2W LARGE DECK LIGHT
 01EL092

1W SMALL DECK LIGHTS (PACK OF 4)
 01EL091

**4
 PACK**



STEP 1 - SELECT YOUR LIGHTS

DECK LIGHT

WARM WHITE / 1W LED (PACK 4) / 2W LED (LARGE)



	1W DECK LIGHT	2W DECK LIGHT
Power	1W	2W
Nominal Voltage	12V	12V
Bulb type	LED Non-replaceable	LED MR11
Lumens	120 LUMENS	170 LUMENS
Cable Length	0.2m	0.2m
Construction	Stainless steel housing Heavy duty glass lens	Stainless steel housing Heavy duty glass lens
Package contents	4 x Light fixture 4 x Bulb	1 x Light fixture 1 x Bulb
Requires	12V transformer <small>(not included in pack and sold separately)</small>	12V transformer <small>(not included in pack and sold separately)</small>
Hole required	32mm Ø	48mm Ø
Product code	01EL091	01EL092

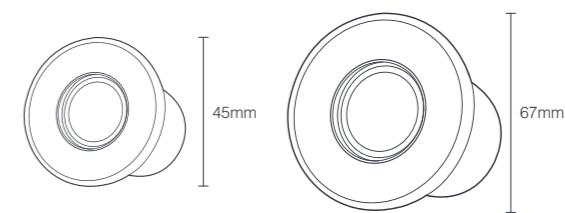

Available as a Starter Kit

Includes: 4 x 1W Deck Lights, 1 x Transformer, 1 x 10m Cable, 3 x 1m Cable, 3 x T-Piece Connectors

Product Code 01EL200



NEW!
Our **0.2m cable** is ideal to use with small decking lights which enables easy access to connectors.

0.2M / 1M / 2M / 5M / 10M
EXTENSION CABLE

02EC200 / 02EC001 / 02EC002 /
021EC005 / 02EC010



T-PIECE
CONNECTOR
02EC003

COMPLETE YOUR
CUSTOM GARDEN
LIGHTING DESIGN
WITH OUR EASY
TO INSTALL PLUG
'N' PLAY WIRING &
CONNECTORS.



STEP 2 - CHOOSE CONNECTORS & CABLES

CABLES & CONNECTORS

0.2M / 1M / 2M / 5M / 10M CABLES / T-PIECE CONNECTOR



	EXTENSION CABLE	T-PIECE CONNECTOR
Length	0.2m / 1m / 2m / 5m / 10m	-
UV Resistant	Yes	Yes
Material	PVC	Plastic
Outdoor Use	Yes	Yes
Connections	1 Male / 1 Female	1 Male / 2 Female
Cable Diameter	1mm ³	-
Product Code	0.2m 02EC200	
	1m 02EC001	
	2m 02EC002	02EC003
	5m 02EC005	
	10m 02EC010	

AUTOMATIC LIGHT SENSOR

AUTOMATICALLY TURN YOUR LIGHTS ON & OFF AT NIGHT. FEATURES A 4 OR 6 HOUR TIMER FUNCTION. POSITION BEFORE FIRST LIGHT. INCLUDES A MALE TO MALE CONNECTOR CABLE.

	AUTOMATIC LIGHT SENSOR
Max Power	100W
Nominal Voltage	12V
UV Resistant	Yes
Material	Black plastic housing
Outdoor Use	Yes
Product Code	02EC020



SO SIMPLE!
The automatic light sensor is a must for every installation, it turns your lights on and off for you.



HANDY HINT

Make sure you tighten the plug connection collars to make sure connections are watertight.

Also, don't loosen the O-Ring.

72W OUTDOOR TRANSFORMER
02ET072

FULLY WATERPROOF TRANSFORMER. UP TO 12 LIGHTS & 50M OF CABLE PER TRANSFORMER.



STEP 3 - GRAB A TRANSFORMER

OUTDOOR TRANSFORMER

72W / 6000MA TRANSFORMER



EXTENSION CABLE

Power	72W / 6000 mA
Output Voltage	12V
Input Voltage	240V
UV Resistant	Yes
Material	Black plastic housing
Outdoor Use	Yes
Cable Diameter	1mm ³
Product Code	02ET072

NOW COMES THE **EASY BIT.**





GET YOUR NEW OR REPLACEMENT BULBS FOR SMALL AND LARGE SPOTLIGHTS, BOLLARD LIGHTS AND LARGE DECK LIGHTS.



ACCESSORIES
BULBS

WARM WHITE / COOL WHITE

	MR11	MR16
Power	2W	3W
Nominal Voltage	12V	12V
Bulb type	LED	LED
Kelvin rating (K)	WARM WHITE 3000K COOL WHITE 6000K	WARM WHITE 3000K COOL WHITE 6000K
Package contents	4 x Bulbs	4 x Bulbs
Requires	12V transformer <small>(not included in pack and sold separately)</small>	12V transformer <small>(not included in pack and sold separately)</small>
Suitable for	Small spotlight & Large deck light	Large spotlight & Bollard light
Product code	WARM WHITE 02EB011 COOL WHITE ELO2EB111	WARM WHITE ELO2EB016 COOL WHITE ELO2EB116

KELVIN RATING

The Kelvin (K) rating refers to the colour of the bulb's light.

The higher the 'K' rating, the whiter the light will be.

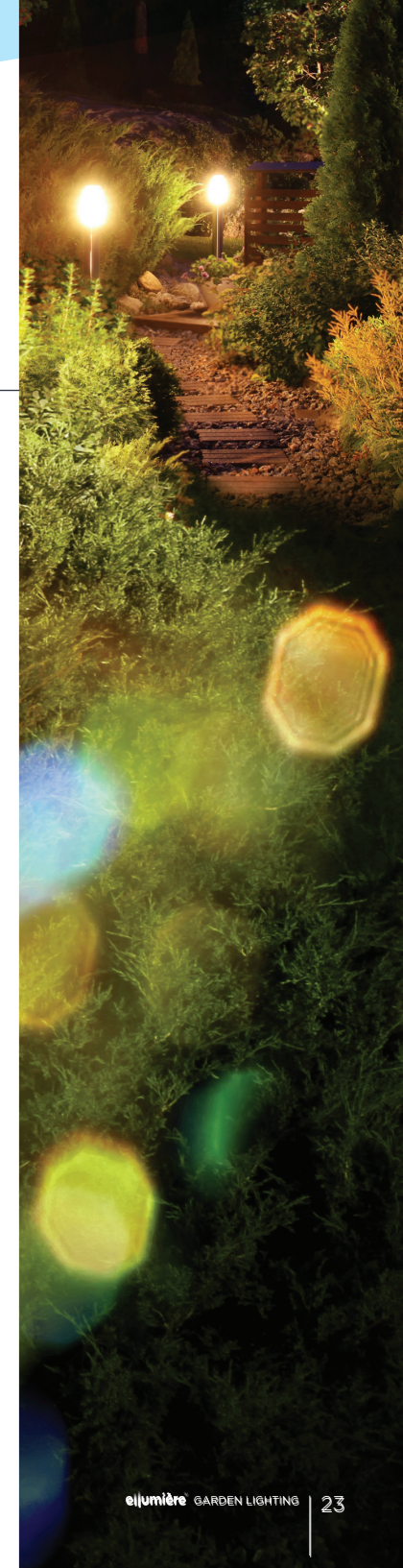



SMALL SPOTLIGHT LENS

- BLUE
ELO2EL057
- GREEN
ELO2EL059
- RED
ELO2EL058



LARGE SPOTLIGHT LENS

- BLUE
ELO2EL055
- GREEN
ELO2EL056
- RED
ELO2EL054

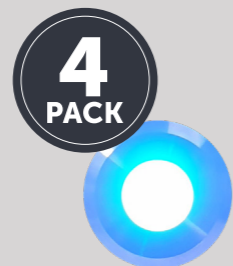

SMALL DECK LIGHT LENS

- BLUE
ELO2EL047
- GREEN
ELO2EL048
- RED
ELO2EL049



LARGE DECK LIGHT LENS

- BLUE
ELO2EL044
- GREEN
ELO2EL045
- RED
ELO2EL046



ACCESSORIES

LENSES

BLUE / GREEN / RED

CUSTOMISE YOUR SYSTEM AND MAKE YOUR GARDEN STAND OUT THROUGH DIFFERENT COLOURED LIGHTS.

	SMALL SPOTLIGHT LENS	LARGE SPOTLIGHT LENS	SMALL DECK LIGHT LENS	LARGE DECK LIGHT LENS
Colour	BLUE GREEN RED	BLUE GREEN RED	BLUE GREEN RED	BLUE GREEN RED
Product code	EL02EL057 EL02EL059 EL02EL058	EL02EL055 EL02EL056 EL02EL054	EL02EL047 EL02EL048 EL02EL049	EL02EL044 EL02EL045 EL02EL046



EASY TO FIT

.....

All of the lenses are simple and quick to fit.

.....

It's as easy as screwing the top off the light and replacing the lens with the coloured one.

IT IS AMAZING HOW
STUNNING YOUR
GARDEN CAN LOOK
WITH THE ADDITION
OF A FEW WELL
PLACED LIGHTS.

CONNEXT
GARDEN LIGHTING SYSTEM

BIRKDALESALES.COM



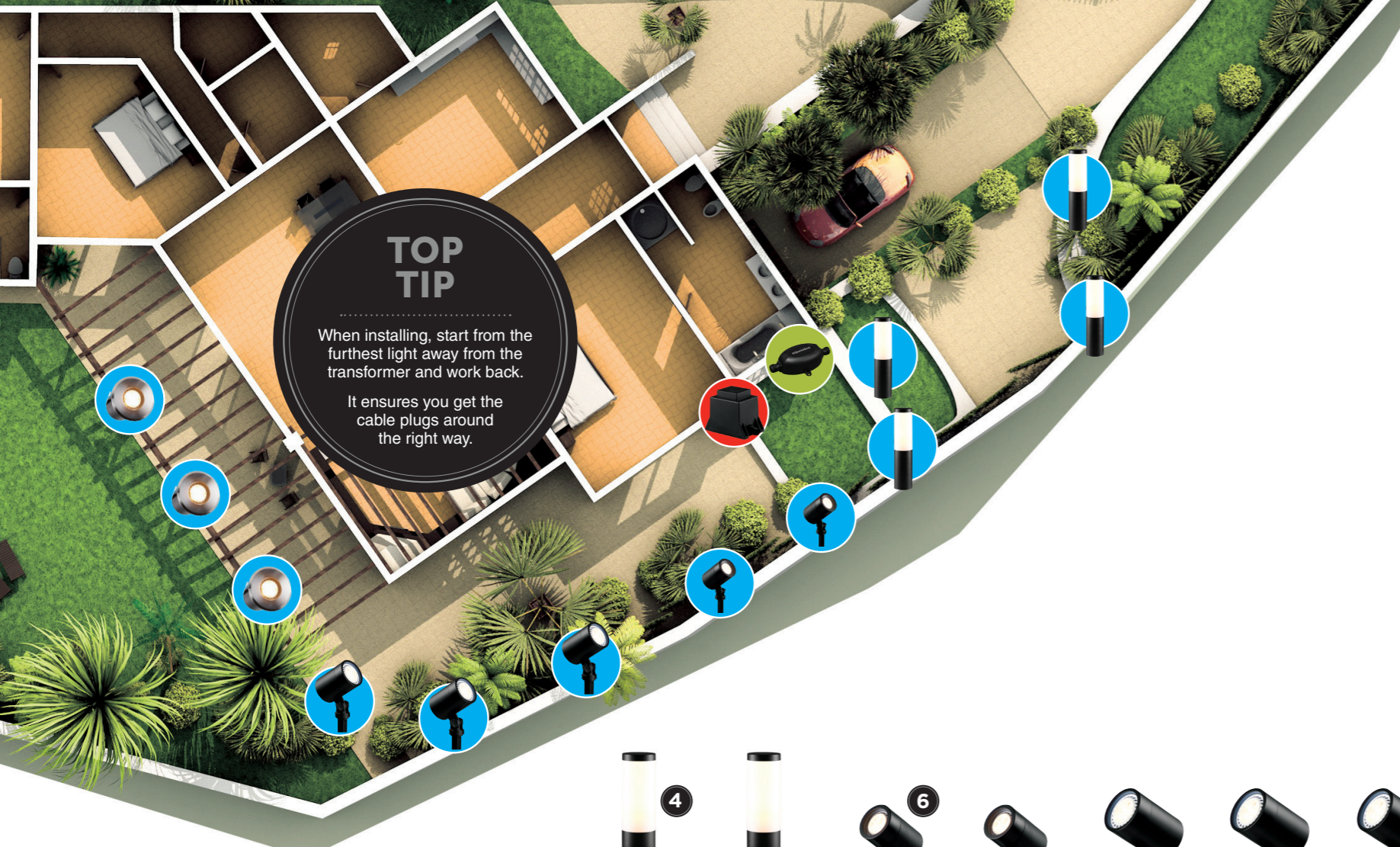

TOP TIP

When installing, start from the furthest light away from the transformer and work back. It ensures you get the cable plugs around the right way.

PLAN YOUR PROJECT

Walk your garden during the day and night to select key focal points and sketch a plan of the area.

Add trees, shrubs, decks, and areas of any significance in the garden to your diagram.

Don't forget to indicate where your power point is located.

Think about what type of lights you would like to have in your garden. Choose from small spotlights to light up smaller plants or larger spotlights to highlight a beautiful tree. Bollard lights are a great addition to a driveway or path, and deck lights create a fantastic feature along the edges of decking or stairs.

Now you have your lights placed, it's time to work out your cables. Measure the distance between each light and back to your power source and write these measurements on your plan.

You will need a T-Piece Connector for every light except the last light in your sequence. Indicate these on your plan.

Now measure the distance from your power supply to the first light and mark this on your plan.

Check the total length of all your cables does not exceed 50m.

Once you're home, simply connect them all up, turn them on, sit back and enjoy. It's that simple.

WHAT WE USED

- 1 Outdoor Transformer
- 2 Automatic Light Sensor
- 3 T-Piece Connectors
- 4 Garden Bollards
- 5 Ext. Cables (1m / 2m / 5m / 10m)
- 6 Garden Spotlights (Sml)
- 7 Garden Spotlights (Lrg)
- 8 Deck Lights

START WITH A KIT OR BUILD YOUR OWN

- Any style or configuration
- Max 12 lights per transformer
- Max 50m per transformer

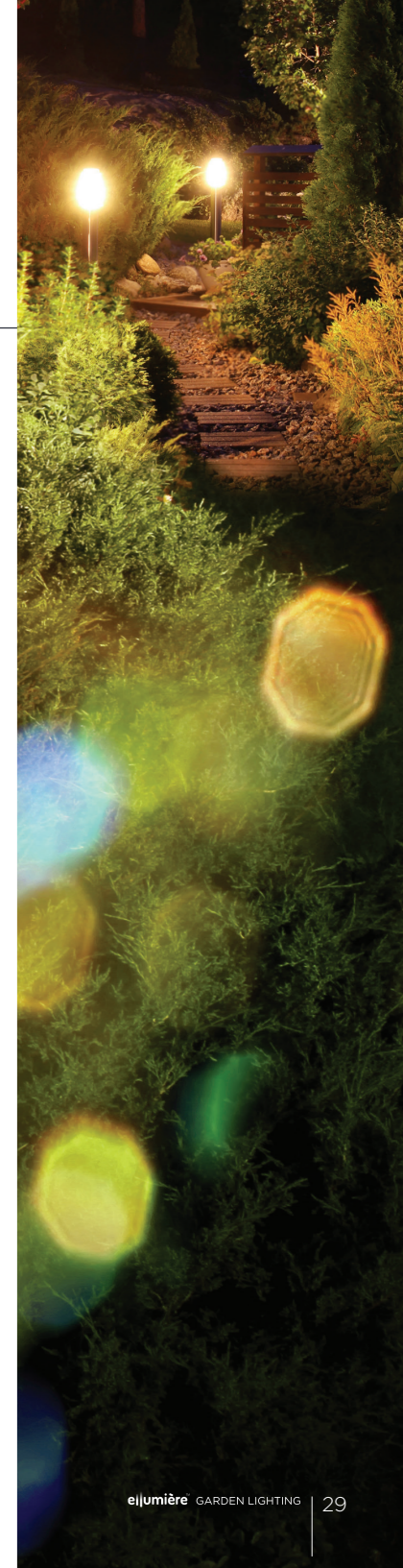
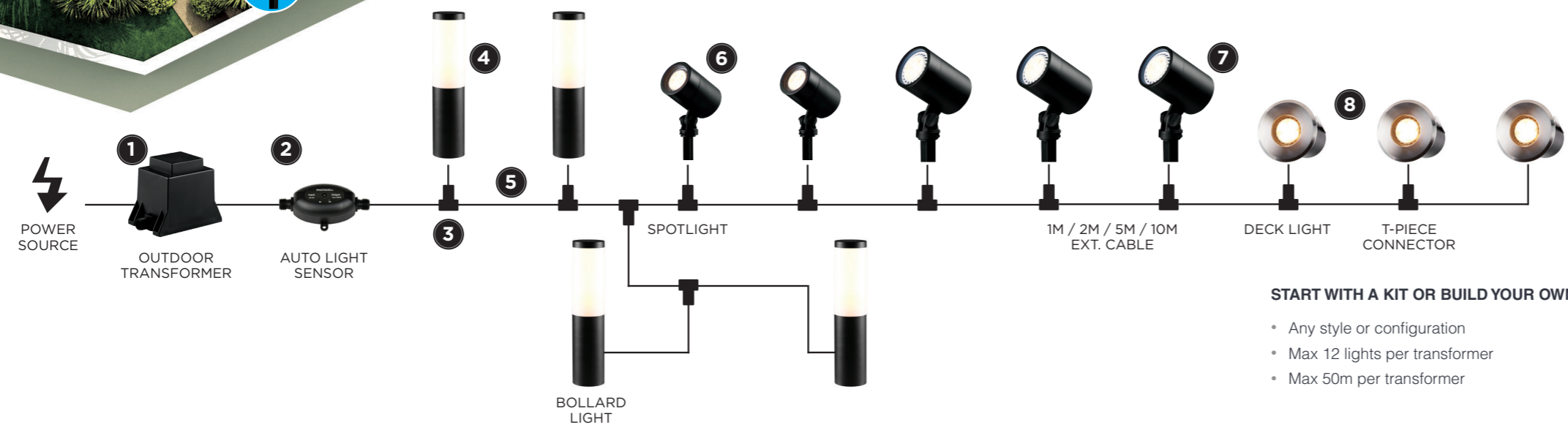



MAKE A START.

PLAN YOUR PROJECT

COMPLETE YOUR GARDEN LIGHTING IN 3 EASY STEPS

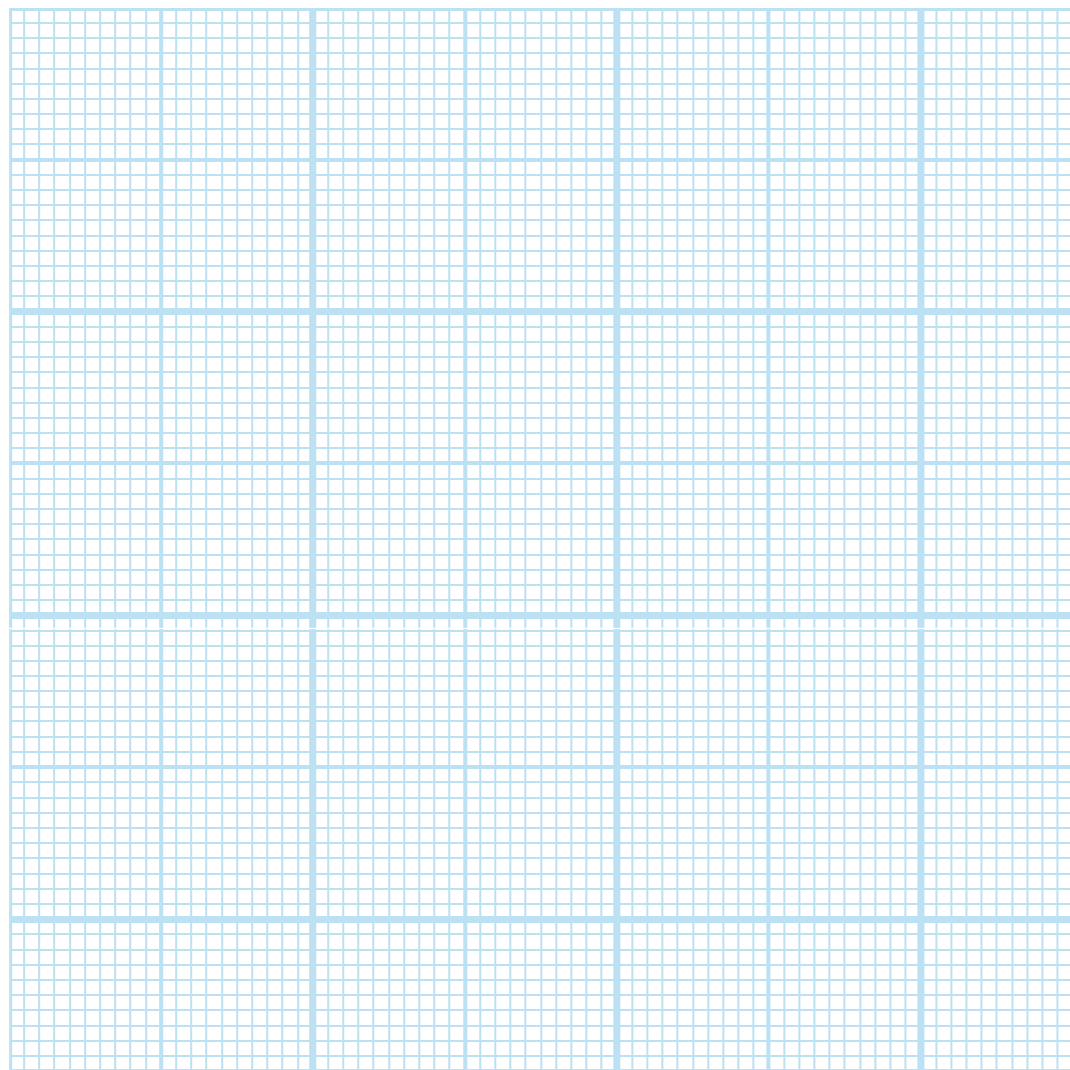

1CM = 2M

NO ELECTRICIAN
REQUIRED. IT'S
THAT SIMPLE



HOW DOES YOUR GARDEN **GLOW**?

e|lumière™
BY BIRKDALE

CONNEXT
GARDEN LIGHTING SYSTEM

Birkdale Sales
Granville House,
The Heights Business Park,
Ibstone Road, Stokenchurch,
Buckinghamshire, HP14 3BG
Tel: 0345 450 9000
Fax: 0345 450 9085
Email: mail@birkdalesales.com
Web: www.birkdalesales.com

